

ACTUATOR LA12

Features:

- 12/24 V DC permanent magnetic motor
- Max. thrust 750 N
- Duty cycle up to 100% at 20°C ambient temperature (see duty cycle graphs)
- Ambient temperature -20° to +40° C.
- Reinforced glass fibre piston rod
- Compact design
- Protection class: IP 51
- Colour: black
- 750 mm straight cable without plug or 2300 mm straight cable with jack.
- Back fixture available in 2 different variants: 01 or 02 (factory mounted)
- Built-in limit switches (not adjustable)
- High-strength plastic housing protects motor and gear

Options:

- Reed-switch
- Potentiometer (max. 100 mm stroke length)
- Protection class IP 65 and IP 66
- ATEX approved for dust explosive atmospheres



Thanks to the small size and outstanding performance, the LA12 actuator provides a practical and cost-effective alternative to traditional pneumatic systems and gear motors.

The LA12 is ideal for automating industrial and agricultural machines, feeding, ventilation systems troughs and many other applications requiring short linear movement.

Technical specifications:

New Type	Old Type	Spindle pitch (mm)	Thrust max. Push/Pull (N)	Self-Lock Max. (Push) (N)	Self-Lock Max. (Pull) (N)	Typical speed 0/full load (mm/s)		Stroke length (in steps of 30 mm)			Typical Amp. at full load (A) 24V - 12V		
12XX00-1XXX12XX		12.1	2	750	750	375	14	5	40	-	130	-	4,6
12XX00-1XXX24XX		12.1	2	750	750	375	14	6	40	-	130	2,2	-
12XX00-2XXX12XX		12.2	4	300	300	150	27	16	40	-	130	-	2,5
12XX00-2XXX24XX		12.2	4	300	300	150	27	16	40	-	130	1,5	-
12XX00-2XXX24XX	#	12.2	4	300	300	150	50	27	40	-	130	2,0	-
12XX00-3XXX12XA		12.3	6	200	200	100	40	28	40	-	130	-	2,2
12XX00-3XXX24XA		12.3	6	200	200	100	40	28	40	-	130	1,0	-

Estimation made in connection with a CBD1.
The above values are with an ambient temperature of 20°C

Dimensions:

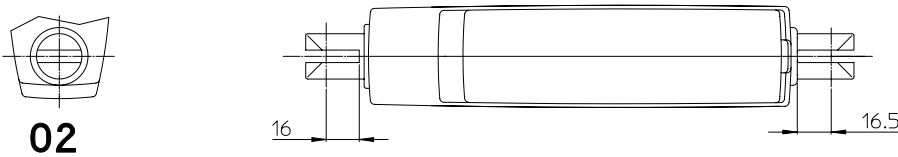
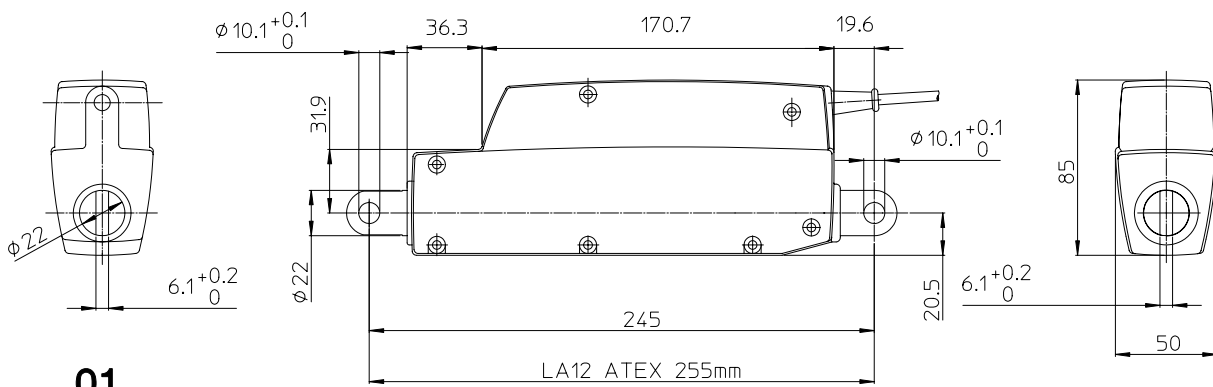

LINAK A/S
LA12001C

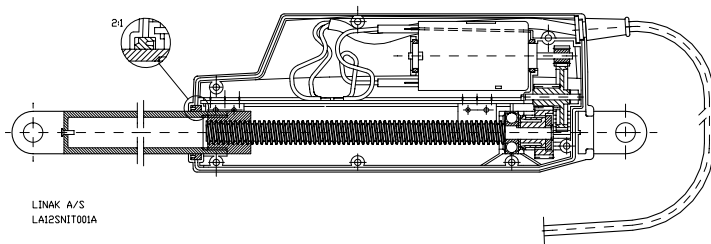

LA12 Curves speed and current:

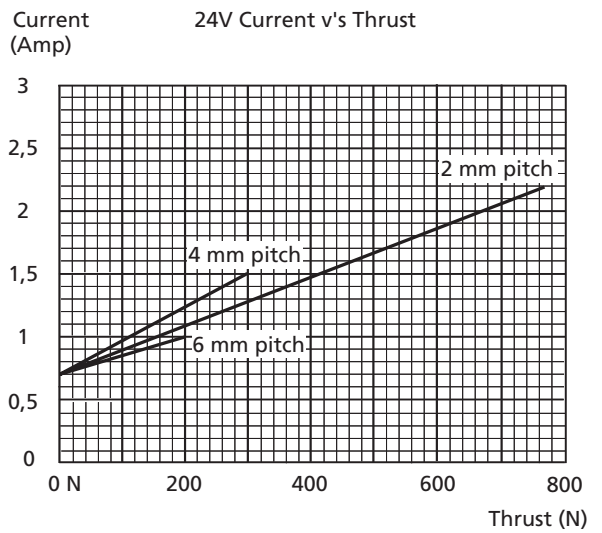
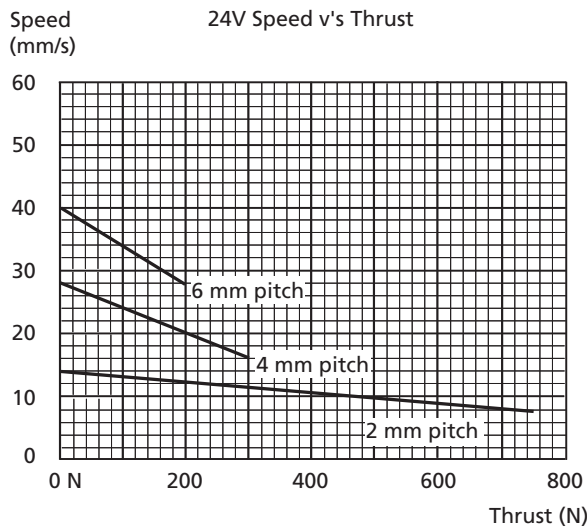
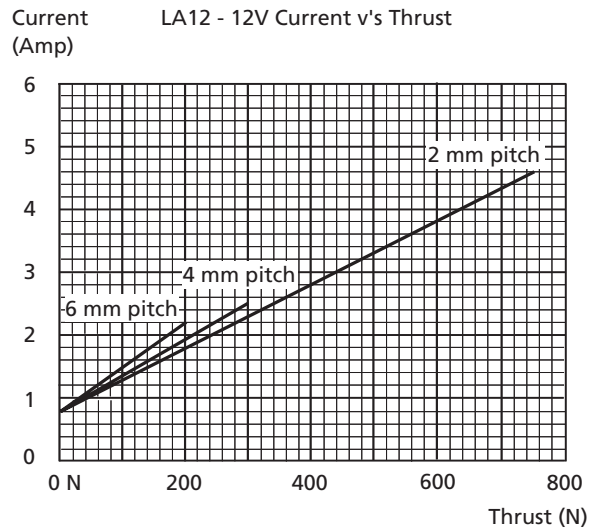
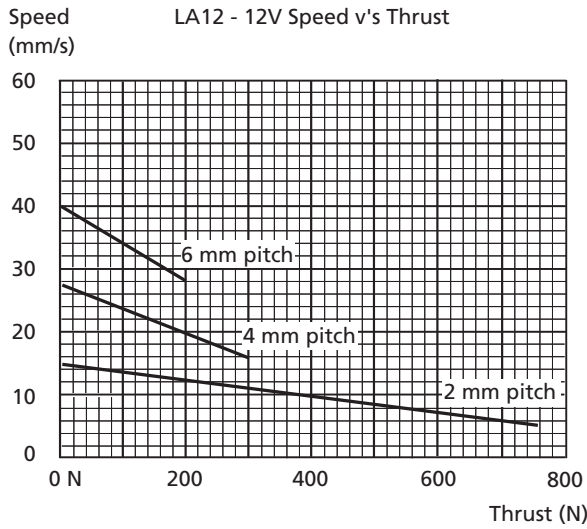

The above values are average values and made with a stable power supply and an ambient temperature of 20°C.

Graphs for Duty cycle

Duty Cycle versus Load - LA12 - 2 mm pitch (24 V)

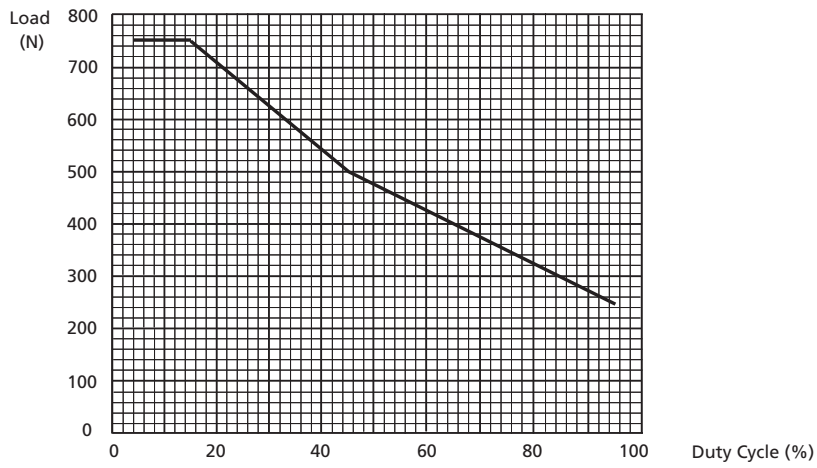

Duty Cycle versus Load - LA12 - 4 mm pitch (24 V)

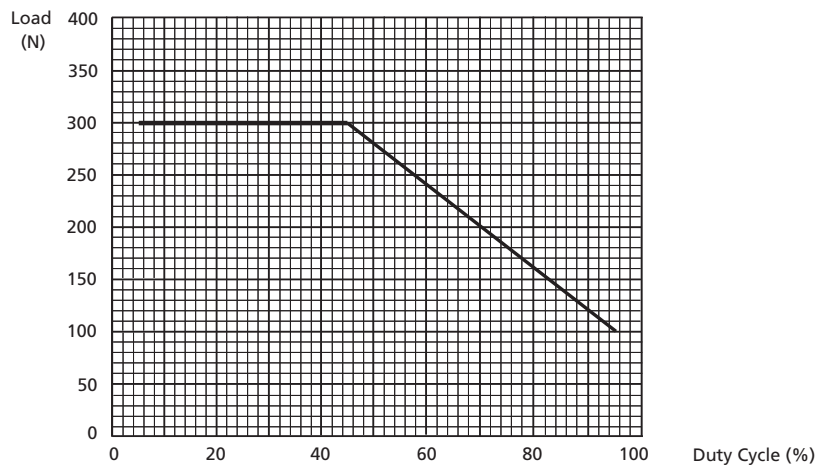

Duty Cycle versus Load - LA12 - 6 mm pitch (24 V)

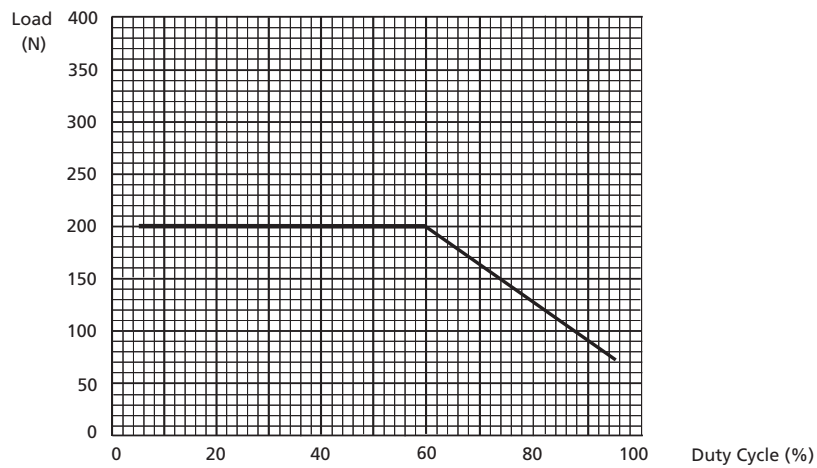

Graphs for Duty Cycle

The graphs on the next page show which duty cycle can be expected compared to the load. The measurements for the graphs have been made with an ambient temperature of 20°C. If the actuator is used in a higher ambient temperature the duty cycle will decrease.

Test conditions for Duty Cycle.

The conditions of the tests carried out at LINAK A/S are as follows:

- Ambient temperature approx. 20°C.
- Actuator running at full stroke (between both end stop switches)
- Actuator running at max. recommended duty cycle
- Continuous operation 24 hours a day
- No vibrations
- Relatively clean environment (no extreme dust or dirt)



Please note that running the actuator in other conditions than the above mentioned may decrease or increase the duty cycle of the actuator. Therefore it is recommended that the customer always tests the actuator in the actual application, to ensure that the actuator fulfills the customers expectations.

Other information:

- It is possible to have other stroke lengths. From 20 mm - 130 mm in steps of 3,75 mm.
- Winding isolation class F (155 degrees).
- Typical noise level dB (A) 55-57 measuring method DS/EN ISO 3746, actuator not loaded.
- The maximum working voltage for the LA12 (24 V motor) is 28 V and 14 V for the LA12 (12 V motor)

LA12

Ordering example:

12 2 M 00 1 100 24 0 4

- Cable:**
 - Without reed:**
 - 0 = Black straight 0,75 m (2-core)
 - 1 = Jack black straight 2,3 m (2-core)
 - With reed:**
 - 2 = 3-core stereo jack black straight 2,3 m
 - 3 = 3-core black straight 0,75 m
 - 4 = 4-core black straight 0,75 m
 - A = DESKLINE cable 2,06 m
 - C = DESKLINE cable 1,56 m
 - E = DESKLINE cable 0,66 m
- IP version:**
 - 0 = IP51
 - 1 = IP65
 - 2 = IP66
 - 8 = IP66 ATEX Zone 21 and 22
- Motor:**
 - 12 = 12 V DC
 - 24 = 24 V DC
- Stroke length:**
 - 040, 070, 100, 130 = standard stroke length
 - XXX = special
- Spindle type:**
 - 1 = 2 mm pitch
 - 2 = 4 mm pitch
 - 3 = 6 mm pitch
- 0 0** Not used
- Positioning:**
 - 0 = none
 - R = Reed switch (3-core) 4 pulses per rev.
 - M = Reed switch (4-core) 4 pulses per rev.
 - P = Potentiometer (5-core)
 - D = Reed switch for DESKLINE cable - 2 pulses per rev.
 - T = Reed switch (3-core) 10 pulses per rev.
 - E = Reed switch (4-core) 10 pulses per rev.
- Back fixture type:**
 - 1 = 01
 - 2 = 02
- Actuator type:** LA12

Note: Positioning / cable choice

- When 0 choose cable 0 or 1
- When R choose cable 2 or 3 (customer shall specify which cable)
- When M choose cable 4
- When Potentiometer choose cable 0 (with potentiometer MAX. Stroke length 100mm)
- When D choose cable A, C or E
- When T choose cable 2 eller 3
- When E choose cable 4



Beware of the direction of travel when ordering LA12 with Jack Plug, or DESKLINE® cable.

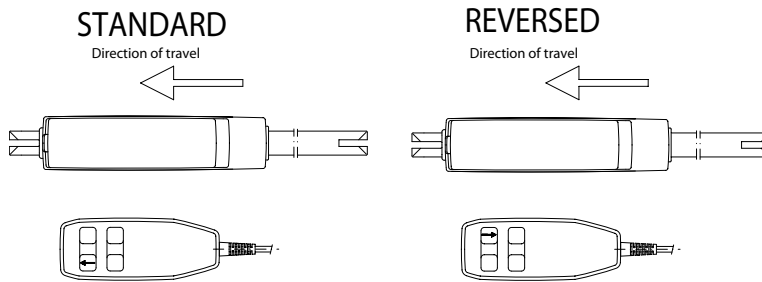

LINAK A/S
LA12dir001A

Connection diagrams:

Actuator with potentiometer

- The built-in 10k. sliding potentiometer makes it possible to decide the position of the actuator. A 1k. dropping resistor has been mounted to protect the potentiometer against overload. Deflection is from 0k. + the dropping resistor's = 1k. (retracted position) to 10k. + 1k. (extended position). The absolute tolerance of the potentiometer is $\pm 20\%$.
- The stroke length is limited to maximum 100 mm. With a stroke length of less than 100 mm the maximum potentiometer deflection will be correspondingly reduced: a stroke length of 70mm gives a deflection of $70/100 = 70\%$ deflection = $7k. + 1k. = 8k.$ (extended position).
- 930 mm straight 5-core cable: red, blue, yellow, green and black.
- The maximum permissible effect of the potentiometer is 0.1 W.
- The actuator, i.e. the motor and the potentiometer are connected as illustrated below:

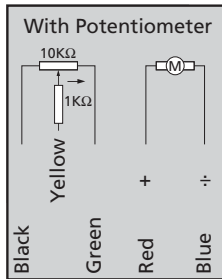

RED	BLUE	
+	-	Out going
-	+	In going

Actuator with potential free reed-switch

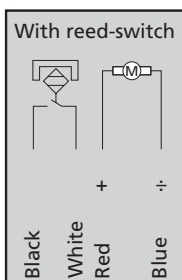

RED	BLUE	
+	-	Out going
-	+	In going

Actuator with reed

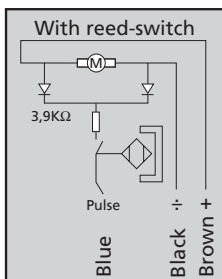

BROWN	BLACK	
+	-	Out going
-	+	In going

Please note that the voltage level of the feedback signal depends on the load of the actuator.

LA12 ATEX

Facts about LA12 ATEX version.

LINAK is able to supply LA12 ATEX for dust explosive atmospheres zones 21 and 22.

There are some differences between the "standard" LA12 and the "LA12 ATEX"

Standard LA12	LA12ATEX
Can be opened and modified by subsidiaries	Must be opened and modified by LINAK A/S only due to the fact that our quality systems have been approved according to ATEX.
Housing is made of plastic	Housing is made of plastic but coated with grey painting that is conductive. This is to prohibit static electricity.
Inner tube is made of plastic	Inner tube is made of stainless steel – the same as used on LA22. This to prohibit static electricity.
Installation dimension 245mm	Installation dimension 255mm due to the fact that the inner tube is made of stainless steel.

SUPPLEMENTARY FOR LA12 ATEX

Installation instructions.

The actuators model LA12 shall be used in a permanently fixed installation.

Special conditions for safe use:

The permanently attached cable shall be terminated in a non-hazardous area or inside an enclosure that is certified under the type of explosion protection as described in EN 50014 clause 1.2.

The duty cycle of the actuator is limited to 6 minutes ON - 54 minutes OFF.

The actuator model LA12 is to be installed where it is protected from direct sunlight.

Specifications subject to change without prior notice.

It is the responsibility of the product user to determine the suitability of LINAK A/S products for a specific application. LINAK will at point of delivery replace/repair defective products covered by the warranty if promptly returned to the factory. No liability is assumed beyond such replacement/repair.