

FOCUS ON

PLATFORMS AND LIFTS



LINAK designs products that improves quality in your working life

www.linak.com/techline

Understanding your needs

Ergonomics is about the interaction between people, work, and the environment around them. The strains that typically occur without the optimal ergonomic conditions are injuries in muscles, joints, and nerves costing companies millions in absence due to illness, health insurance, etc. With very simple adjustments of the production facilities it is possible to minimise the risk of injuries caused by insufficient ergonomics.

Ergonomics is a key issue at LINAK with the slogan “we improve you life” we try to create better conditions for the employees in their daily work. It all started in the offices where almost all desks are height adjustable.

Now the focus has changed towards the industrial working places where we see more and more modern companies that are heavily investing in ergonomic solutions for the production facilities. They do so because they know that the return of investment will be very short due to drops in illness rates and much higher productivity.

LINAK understands your business and knows the importance of flexibel and reliable solutions. Keywords such as plug and play solutions, design, high degree of safety, and focus on ergonomics among others are essential subjects when selecting solutions.



Choose LINAK for...

A Knowledgeable Partnership

Multilevel cooperation with our customers is extremely important, for the benefit of both LINAK and the customer. Partnership is the driving force behind R&D, aftersales, logistics, manufacturing, and marketing.



LINAK has many years of experience as a sub-supplier within this business and knows what it takes to supply actuator systems that put flexibility and reliability first.

So what can LINAK do to improve the ergonomics and the company profits?

- Supply of reliable products designed specially for the platforms and lifts business.
- One supplier of complete actuator/column solutions for almost any need.
- Maintenance-free products with a long lifetime.
- Electrically solutions with a very high capacity
- Close cooperation with our sales and application engineers, represented in more than 30 countries.

Benefits for the employees:

- Fewer chronic problems
- Improved working environment
- Prevention of muscle inactivity
- Comfortable working posture
- Higher degree of satisfaction

Benefits for the company:

- Increased motivation and job satisfaction
- Increased performance and efficiency
- Decrease of absenteeism due to illness
- Increased product and service quality
- A more dynamic and efficient working style

The most important tool that a company can have is committed and satisfied employees.

EXAMPLES OF PLATFORMS AND LIFTS

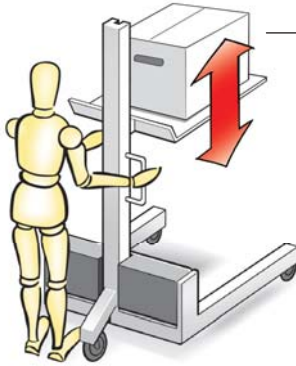

Stackers

The versatility of stackers make them ideal for feeding pallet racks as well as any other pallet storage or transfer operations.

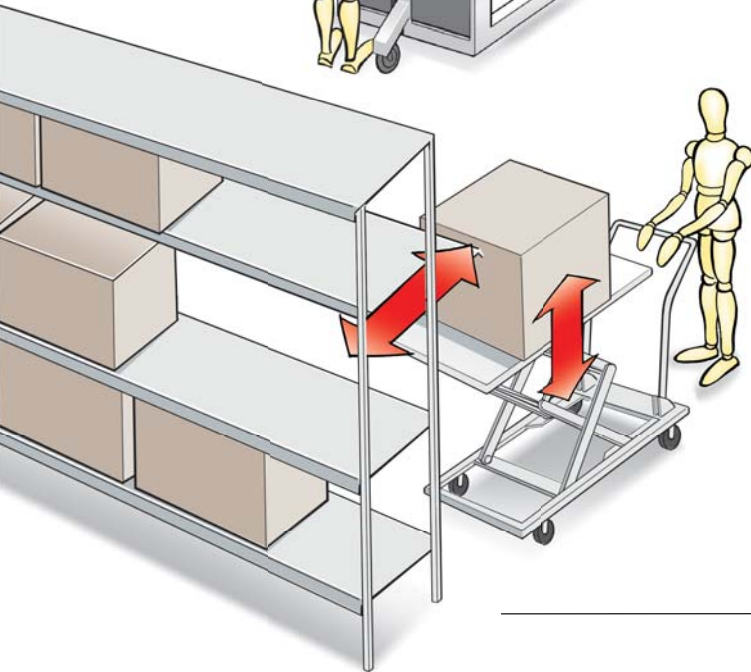

Material handling

All kinds of material handling, portable lifts, and stackers. Electrical solutions improve the flexibility in the stock area.

Choose LINAK for...

Knowledge

At LINAK we focus on our core competence – production of actuator systems. But we do more than this. We want to understand our customer's business by focusing on the individual customer's needs, market intelligence, and application know-how.



LINAK

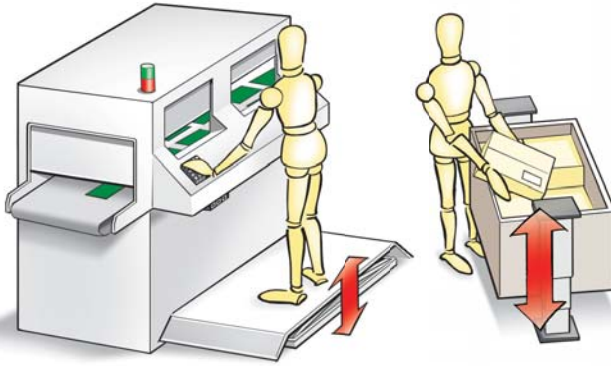

Work platforms

Can improve the ergonomic working positions, for increased motivation and job satisfaction, which can result in less absence due to illness etc.

Lifting trolleys

Electrically operated lifting trolleys can be used all over in the industrial world, in workshops, warehouses, hospitals, production facilities, and in private houses etc. This application is so versatile that it cannot be limited.



Workshop lifts

At workshops many heavy units have to be lifted up in order to have a good and comfortable working position in order to carry out the work in a proper and safe way.

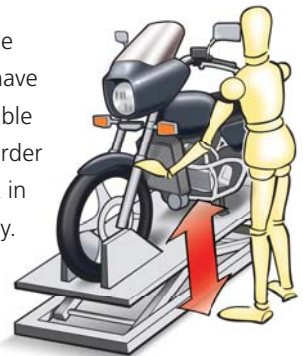

ACTUATORS IDEAL FOR PLATFORMS AND LIFTS

DURABLE AND RELIABLE

The LA36 has been developed for harsh conditions and is the most robust actuator in our program.

Trust:	Max 10,000 N
Speed:	15-160 mm/sec
Stroke length:	50-999 mm
Duty cycles:	up to 20%
Voltage:	12, 24 or 36 V DC
End-stops:	Slip clutch or built in limit switches

- Solid metal construction
- Hand crank for manual operation
- Salt and chemical tested
- High pressure cleaner-proof

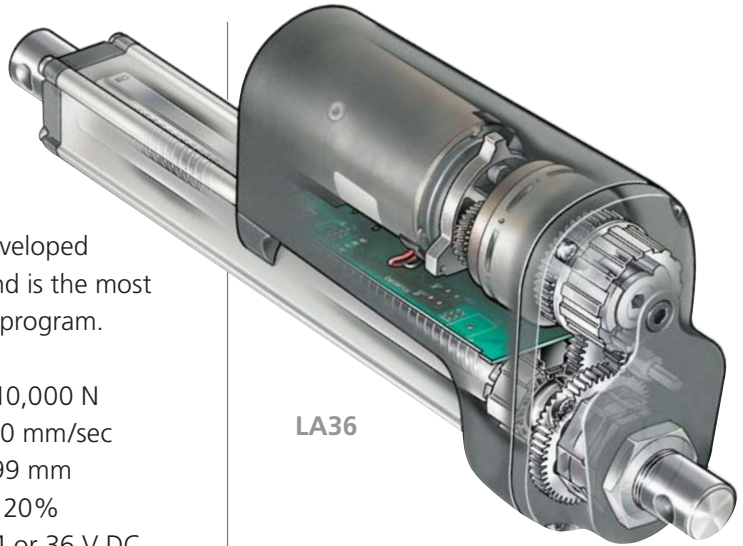

LA36

Choose LINAK for...

Robust and powerful

LINAK products are reliable products, made to last! High quality is the trademark of LINAK, and an element of the highest importance to us.



FLEXIBLE AND POWERFUL

- Max thrust up to 6,000 N in push and up to 4,000 N in pull
- Heavy-duty aluminium housing for harsh conditions
- Protection class IP 66 dynamic, IP 69K static
- Stroke up to 600 mm
- Easy to use interface – with integrated power electronics for direct connection to control system
- Potential free limit switches as an option
- Hall sensors or potentiometer for relative or absolute feedback, regardless of the stroke length.
- Built-in limit switches and brake
- Voltage 12 or 24 V DC

The LA35 actuator is a new member of the TECHLINE® family. It is characterised by its robust design allowing the actuators to be used in harsh and extreme conditions. The LA35 actuator is designed to meet the challenge, based on the philosophy that it must be able to operate on off-highway equipment such as agriculture, forestry and construction machines.



LA35

ACTUATORS IDEAL FOR PLATFORMS AND LIFTS

RUGGED AND COMPACT

- Max thrust up to 6,000 N
- Max speed up to 65 mm/sec
- Standard stroke 50-600 mm
- Stainless steel piston rod
- Protection class IP 66
- Potentiometer for positioning
- Elegant and compact construction with small installation dimensions
- Self-locking ability

The LA30 actuator has been in the industrial market for more than 20 years. It is a very reliable and versatile actuator for all kinds of industrial applications.

LA30



STRONG AND QUIET

- Max thrust up to 10,000 N
- Max speed up to 18 mm/sec
- Standard stroke up to 600 mm
- Protection classes IP 54 or 66
- All critical parts are designed in metal
- Built-in limit switches

The LA34 actuator is an advanced high-tech actuator, which can push up to 10,000 N.

Its compact design, outstanding performance, and range of safety options makes the actuator the ideal choice for a variety of lifting applications.

LA34



Choose LINAK for...

Global Presence

LINAK has a well-developed sales and service organisation in Europe, America, Asia and Australia. Therefore, we can assist you and your customers locally, under the global sales concept idea:

Be global, act local



FLEXIBLE AND POWERFUL

- Protection against dust and water: IP 66, on the electronic box (not for wash-tunnels).
- Colour: Grey and dark grey pedals
- Control of one or two channels
- Modular system
- Protection class IP 67 on electronic box (not for wash-tunnels)

FS



JUMBO SET

- Battery pack for mobility
- Plug and play solution ready to be mounted on your lift etc.
- Can operate with almost any LINAK actuator

A JUMBO battery pack and a LA34 actuator is a plug and play unit that is perfect for all kinds of lifting applications.



SOLUTIONS FOR PLATFORMS AND LIFTS

EASY CONTROL

The DP Desk Panel is a compact unit, which offers you the choice of memory with up to 4 memory positions or e.g. control of up to 3 independent desks. Furthermore, the DP is available in different versions offering e.g. a lock function (with key) or display.



DP1

DE LUXE MODEL

The CBD4 control box is an innovative microprocessor based control box, which ensures an optimum parallel drive, memory, and a very low noise level. The mains cable is exchangeable.

CBD4



Choose LINAK for...

World class operation

The LEAN philosophy permeates our entire production and way of thinking. For the customers it means that we deliver the right products, in the right quality, on time - at a competitive price.



STEADY AND STABLE

- Max load per leg 1,000 N
- Stroke length up to 500 mm
- Speed 50 mm/sec unloaded
- Very high self-locking ability
- For single operation

The DL2 is designed for applications where it can be operated as a single column or in parallel. An obvious choice for height adjustable workstations, conveyor belts etc.



EXTREMELY POWERFUL

- Max load per leg 6,300 N in push
- Stroke length up to 500 mm
- Up to four columns in parallel
- Extremely high self-locking ability

The parallel functionality gives a variety of application opportunities from work platforms to advanced industrial automation.



ACCESSORIES

BATTERY SOLUTIONS

Specially designed for mobile lifts it can run up to 2 actuators.
The JUMBO battery pack can operate with almost any LINAK actuator.



JUMBO system

CB8-A



The CB8-A control box is a battery operated control unit, which can control up to three actuators.

COMPLETE CONTROL

- Power supply in 230 V AC 50/60 Hz 150 VA
- Out 24 V DC 6 A nominal
- Max 10 Amp.
- With or without TR-EM-208

(*)



CONTROL BOX

Choose LINAK for...

Innovation

Innovation is the keyword to the success of LINAK. Today LINAK is the company within manufacturing of linear actuator systems to bring most new products to the market and to hold most technology-based patents. Therefore, we can always offer the newest technology, giving our customers a competitive edge.

COMPLETE CONTROL

- Variable power supply 12-36 V DC
- Overload protection - adjustable current limit 1-20 A
- Adjustable soft start and stop
- Several versions for different applications
- Integrated brake

(*)



**MOTOR CONTROLLER
TR-EM-208**

COMPLETE CONTROL



PARALLEL CONTROLLER

EASY OPERATION

- For all actuators with limit switches
- Easy operation of actuators without use of further electronics
- IP 66 for outdoor use
- Easy to install
- Tested with an LA36 12 V DC for 50,000 operations

(*)



ROCKER SWITCH

- Synchronized parallel control for 2 actuators
- Operates with pulse feedback (Hall or Reed)
- Current and temperature limited
- soft start/stop
- Adjustable drive speed
- Accurate repeatability
- Easy setting via serial interface

(*)

(*) "The specified product is a third party product that is produced by third party and distributed by LINAK as a supplement to LINAK's existing product range. It is the responsibility of the product user to determine the suitability of the product for a specific application. LINAK will at point of delivery replace/repair defective products covered by the warranty if promptly returned to LINAK."

OTHER CAPABILITIES

TECHLINE® - FOR HARSH CONDITIONS

The TECHLINE® systems ease the load and make work easier. The remarkably wide product range offers something for any imaginable type of movement i.e. in industrial and agricultural machinery. With these actuators you can easily reach inaccessible places, open or close sun blinds and roof windows, regulate ventilators, close gates automatically – and save yourself exertion.

- For harsh conditions
- High speeds
- Strong forces
- Long lifetime
- No maintenance

Stationary applications

Linear actuators make it possible to easily and economically adjust various functions in a wide number of stationary applications. LINAK TECHLINE® solutions can improve several facets of your company's working environment including ergonomic lifting, cost-effective automation, and ventilation.

Our comprehensive product programme can be tailored to match your specific needs. LINAK TECHLINE® solutions allow you to adapt your workplace to your workers rather than the other way round.

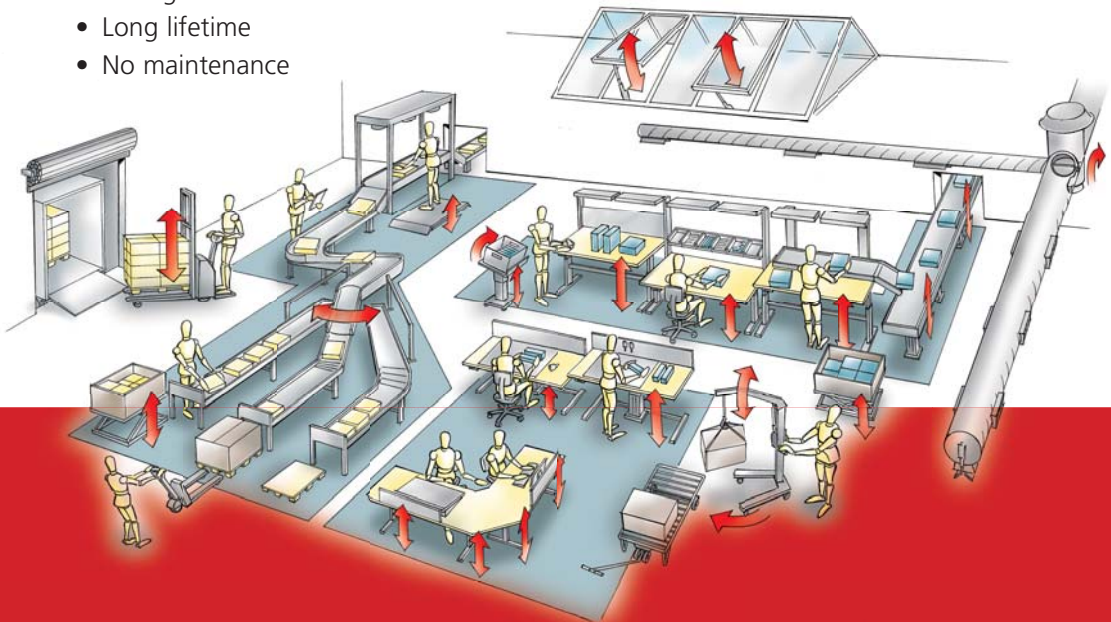

Mobile applications

Linear actuators from LINAK can be used for thousands of different applications. We offer big advantages compared to other linear movements in mobile equipment. Please contact your local LINAK office who has extensive experience in integrating our products into different applications.

When LINAK develops and produces products, quality is the keyword for our employees. LINAK constantly strives to improve the quality and to reduce the risk of faults, which contributes to the fact that our customers experience LINAK as a supplier of high-quality products.

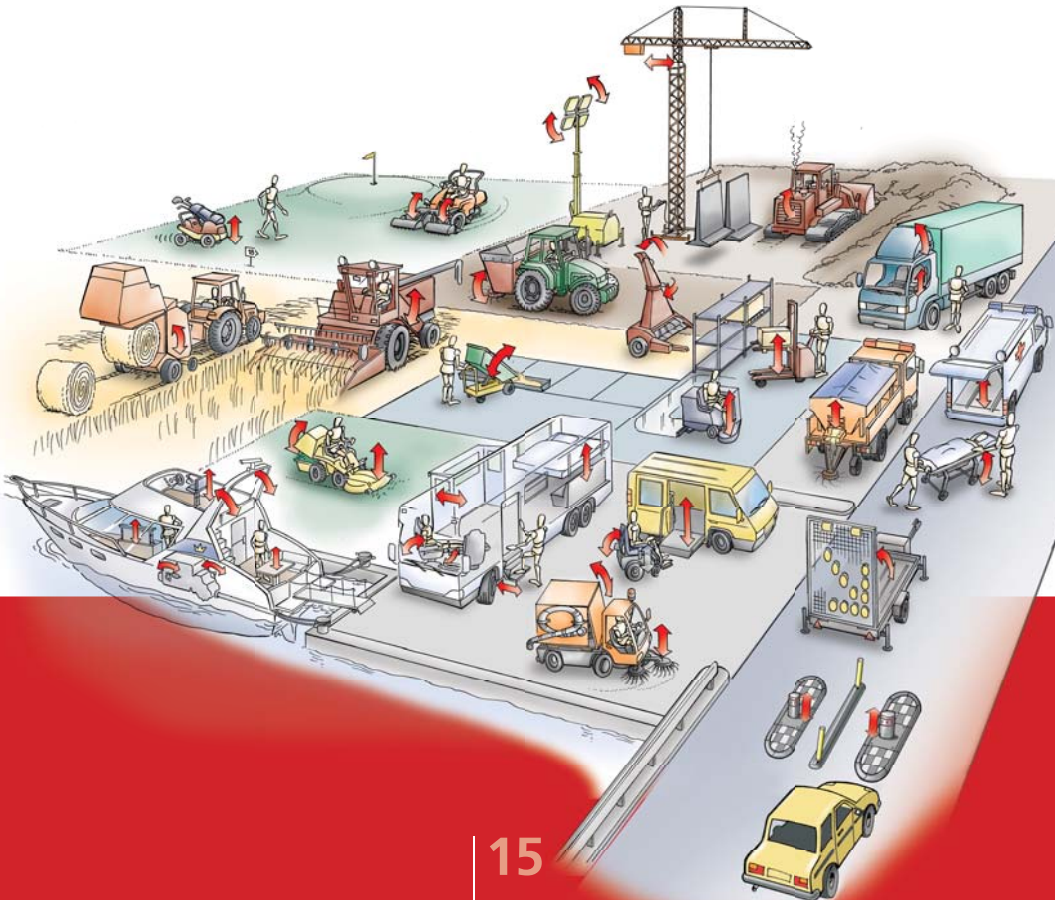

LINEAR ACTUATOR TECHNOLOGY

LINAK - many years of experience from the industry

LINAK has over 25 years' experience as a supplier of linear movement for a broad selection of mobile and stationary applications in the industrial sector.

Application examples are automation of machine plants, adjustment of agricultural equipment, regulation of roof light windows, ventilation systems, combine harvesters, assembly lines, kettles, valves, and throttles. In brief, any purpose in the industry where a linear movement is required and where LINAK TECHLINE® can be used to facilitate working operations and maintenance.

TERMS OF USE

The user is responsible for determining the suitability of LINAK products for a specific application. LINAK takes great care in providing accurate and up-to-date information on its products. However, due to continuous development in order to improve its products, LINAK products are subject to frequent modifications and changes without prior notice. Therefore, LINAK cannot guarantee the correct and actual status of said information on its products. While LINAK uses its best efforts to fulfil orders, LINAK cannot, for the same reasons as mentioned above, guarantee the availability of any particular product. Therefore, LINAK reserves the right to discontinue the sale of any product displayed on its website or listed in its catalogues or other written material drawn up by LINAK.

All sales are subject to the Standard Terms of Sale and Delivery for LINAK. For a copy hereof, please contact LINAK.

www.linak.com/techline



WE IMPROVE YOUR LIFE